

产品型号(MODEL NO.): BWP 10002-A1

产品尺寸 ( SIZE ): 200×94×45MM

产品重量(WEIGHT): 195 g

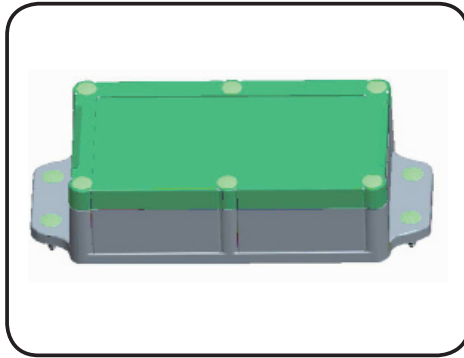

11222002

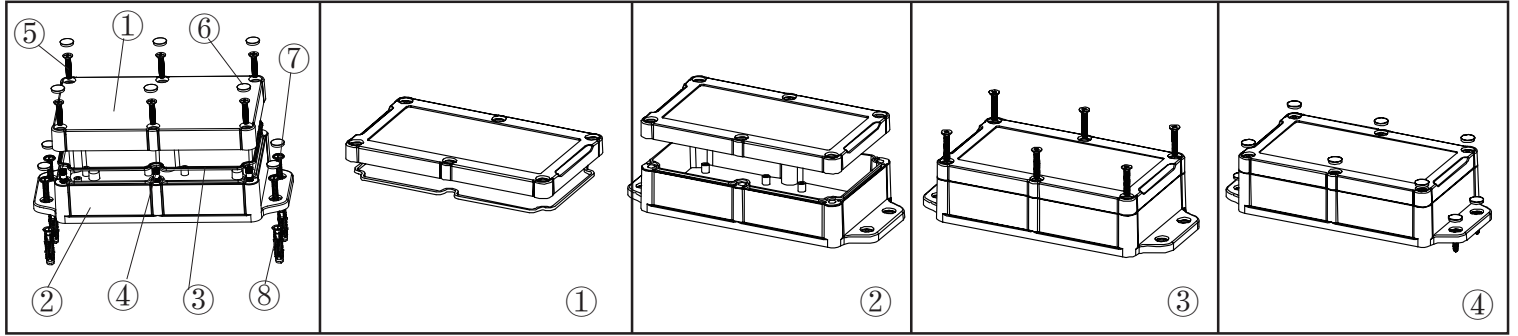

①



产品编号(NUMBER):10002-B1  
 产品名称(NAME):上壳 EPIVALVE  
 模具编号 (P/NO) :BAH10025-A3  
 材料(MATERIAL):ABS(LIGHT GREY:FS20412)  
 用量(QUANTITY):1 PCS  
 重量(WEIGHT) : 66 g

②

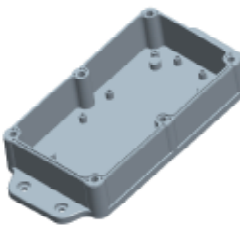

产品编号(NUMBER): 10002-C1  
 产品名称(NAME):下壳 HYPOTHECA  
 模具编号(P/NO): BAH10025-A1A2  
 材料(MATERIAL):ABS(LIGHT GREY:FS20412)  
 用量(QUANTITY): 1 PCS  
 重量(WEIGHT): 129 g

③



产品编号(NUMBER): 10002-D1  
 产品名称(NAME):防水圈GASKET  
 材料 (MATERIAL): 橡胶RUBBER  
 用量(QUANTITY): 1 PCS  
 尺寸 (SIZE): 155x87x1.8 MM  
 重量(WEIGHT): 2 g

④

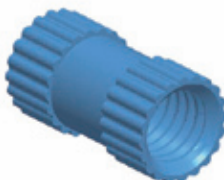

产品编号(NUMBER): M4×10  
 产品名称(NAME):铜套 COPPER NUT  
 规格(STANDARD): M4×10  
 材料(MATERIAL):铜 COPPER  
 用量(QUANTITY): 6 PCS  
 颜色 (COLOR): 铜色 COPPER

⑤



产品编号(NUMBER): KM4×18  
 产品名称(NAME):GRUB SCREW  
 规格(STANDARD): M4×18  
 材料(MATERIAL): STAINLESS STEEL  
 用量 (QUANTITY): 6 PCS

⑥

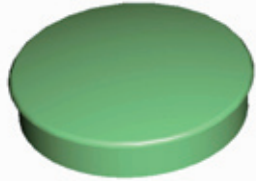

产品编号(NUMBER): KN-500-B1  
 产品名称(NAME):螺丝盖 SCREW LID  
 模具编号(P/NO): BAH10001-A3  
 材料(MATERIAL): ABS(LIGHT GREY:FS20412)  
 用量(QUANTITY):10 PCS

⑦



产品编号(NUMBER):PWA4×30  
 产品名称(NAME):自攻螺丝SELF-TAPPING SCREW  
 规格(STANDARD): M4×30  
 材料(MATERIAL):铁 IRON  
 用量(QUANTITY): 4 PCS

⑧



产品编号(NUMBER): S-6  
 产品名称(NAME):墙钉 WALL NAIL  
 模具编号(P/NO): BAH10032-A1A2  
 规格(STANDARD): S×6 φ4-5  
 材料(MATERIAL): PP(GREY:CM906)  
 用量(QUANTITY): 4 PCS

名称 NAME	尺寸 SIZE (MM)	CARTON No.	G . W (KG)	N . W (KG)	每箱数量 QUANTITY	PE袋 POLYBAG
小箱 SAML CARTON	220×105×54		0.266	0.216	1 (PCS)	300X165 (MM)
大箱 BIG CARTON	553×438×670	30	33.5	31	120 (PCS)	